



# CobraRTP

Honda Edition R8-10

User Manual

Rev. 1.1



---

## BASIC CONNECTION AND INSTALLATION

First of all, your ECU must be prepared for Chip tuning, ie installed chipping kit (socket for the chip (round or V-shaped), removed J12 (or J4 for JDM) and more). Chipping kit is not included with CobraRTP!

Installation in the ECU is done using the pin contacts in the chip socket, as shown below, using the example of USDM OBD1.

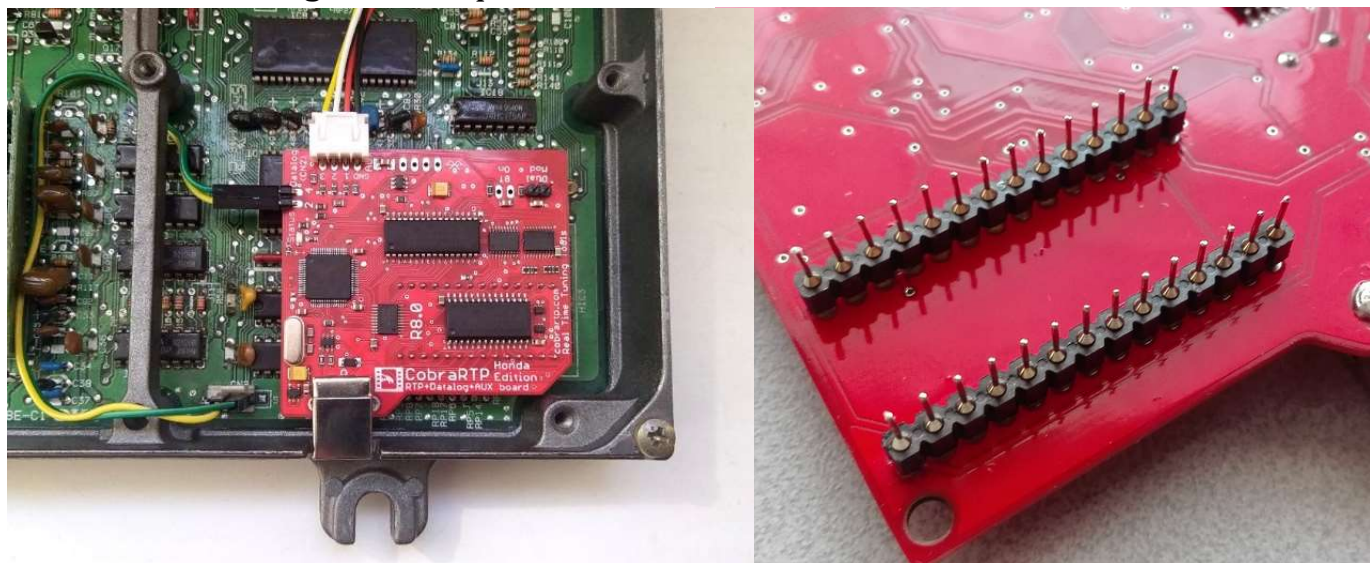

To ensure access to the CobraRTP USB port, it is necessary to make a cutout in the ECU case.



**Warning:** It is worth paying special attention when installing (removing) the board in ECU, as well as during storage, since the type of pin contacts (round) shown in the photo above have low strength and can be prone to kinking under light load or when the board falls without protection.

The **Datalog** is connected to the ECU (connector **CN2** ) using a cable from the kit, as shown above.

As you can see, two data lines are used for the connection - **RX** and **TX** , respectively **2** and **4** pin of connector **CN2** in the ECU. This is true for both USDM, EDM and the JDM type.



**Warning:** Do not touch the board when power is on! It can do damage under static voltage!

---

## CONNECTION TO PC

Connect Honda Edition to a PC using a standard USB type-B cable.

CobraRTP can only connect to a PC, ie There is no need to install (connect) the emulator to the ECU, or connect a separate power source.

### Installing the USB driver

If you have Windows 10/11, then installing drivers for revision R8.1 and higher is not required - the drivers are included with these operating systems. You can find the COM port numbers in the Device Manager.

Driver installation is only required for Windows XP, Vista, 7, 8.x. To do this, you need to download the driver from the site on the "downloads" page: <https://cobrartp.com/en/downloads>. Next, unpack the archive and install the driver using the installer (exe):

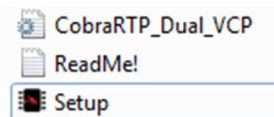

*Check out the info in the Readme!*

```
Process started...
Driver has been successfully installed.
ExitCode: 259
Press any key for exit...
_
```

*Successful driver installation*

After installing the drivers, if there is a connected device, the device manager will display the ports and their numbers:



In windows 7 example

As you can see, one of the ports is for **Emulation** (RTP), the second is for **Datalog**.

**Notes:** The driver does not have a Microsoft digital signature, therefore, for correct operation, "Verifying the digital signature of drivers" must be [disabled](#).

---

## Check connection

To test the CobraRTP device, you can use **CobraRTP Utility** .

You can download the latest version on our website in the " *Downloads* " section. The number of the required COM-port for emulation (RTP) will be selected automatically and displayed in the status-bar of the program:

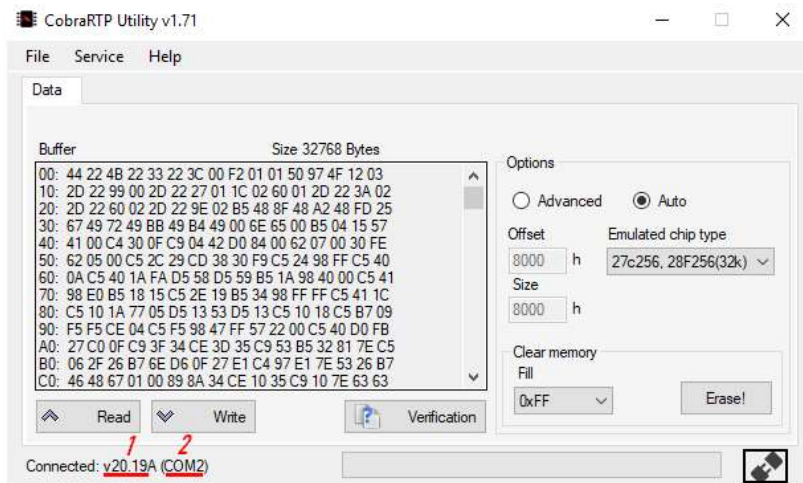

1. – emulator software version .
2. – the number of the active (used) COM-port (for emulation).

Accordingly, the second added COM-port number when connecting the device will be used for **Datalog**.

More info: <https://cobrartp.com/en/cobrartp-utility/>

# BASIC TUNING SOFTWARE CONFIGURATION

**Before Running The Emulator In eCtune , HTS , Crome and etc., you Must Make Sure That The Current Target Software Id Corresponds To The Program You Intend To Use (See Cobrartp Utility) :**

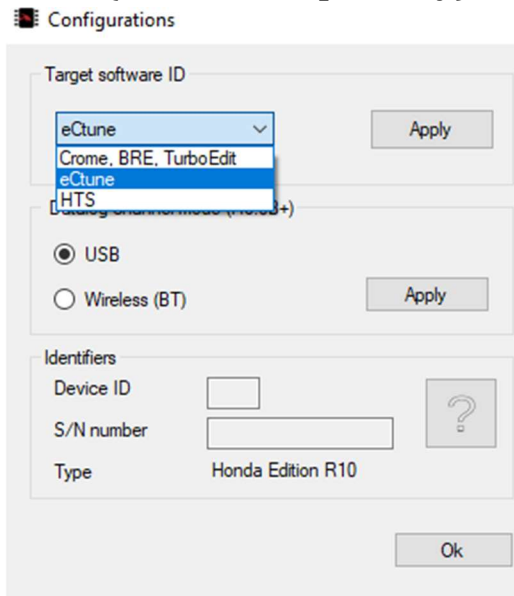

Service->Configurations

To change, you must select the appropriate software in the list and “ *Apply*” for saving.

## eCtune (OBD1):

You Need To Download The Prepared Version On Our Website In The "Downloads" Section.

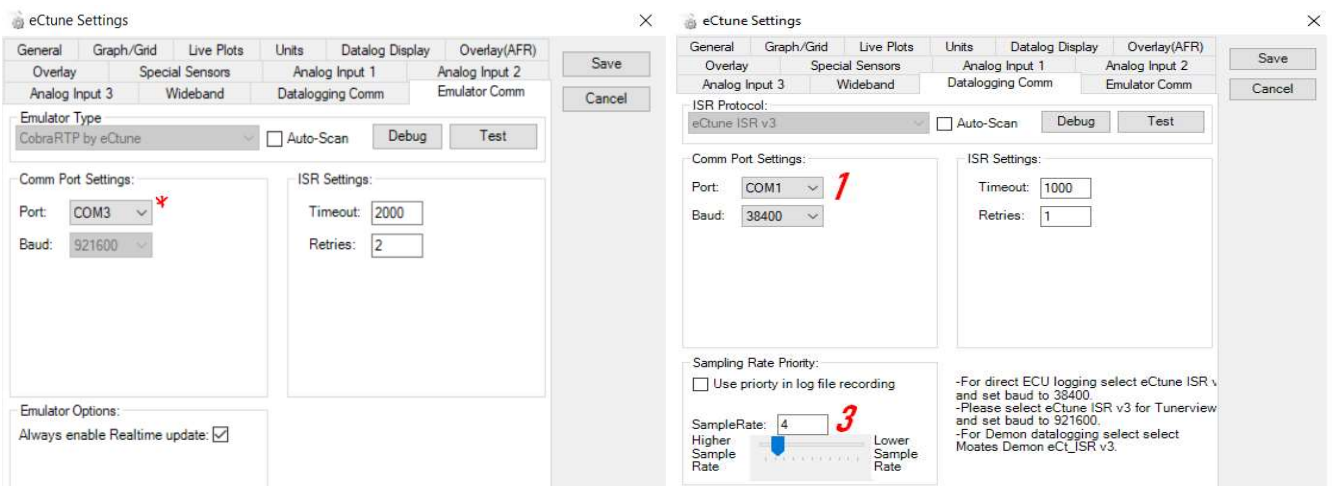



## Notes

\* Port for emulation (same as in CobraRTP utility)

1) Port ( Datalog ) - for datalog , usually one more than the emulation port number (see Device Manager (COM & LPT)).

3) Datalog speed rate for the datalog (do not neglect).

## HTS(OBD0/OBD1):

<https://hondatuningsuite.com/>

The screenshot shows the 'Settings' window with the 'Tuning/Logging' tab selected. The 'Emulator / Datalogging' section is active, showing 'Emulator: CobraRTP'. Under 'Serial Port', the 'Emulator' section has 'Port: COM1' and 'Baud: 921600'. The 'Datalog' section has 'Port: COM2' and 'Baud: 38400'. The 'Secondary Datalogging Output' section has 'COM: COM15' and 'ISR'. The 'Serial Retries: Serial Timeout(ms):' is set to 2000. The 'Datalog Sampling Rate' section has 'Sample Rate: 0' and 'Priority in recording' unchecked. The 'Live Graphing(can be slow)' section has 'Enable Live Graphing' unchecked and 'Retain Data for: 800 frames'.

## Notes

- Port (Emulator) - for emulation (same as in CobraRTP utility)

- Port ( Datalog ) – for datalog , usually one more than emulation port number (check in Device Manager (COM & LPT)).

- Baud - data speed, set as in the image.

## Crome (OBD1):

<https://www.tunewithcrome.com/>

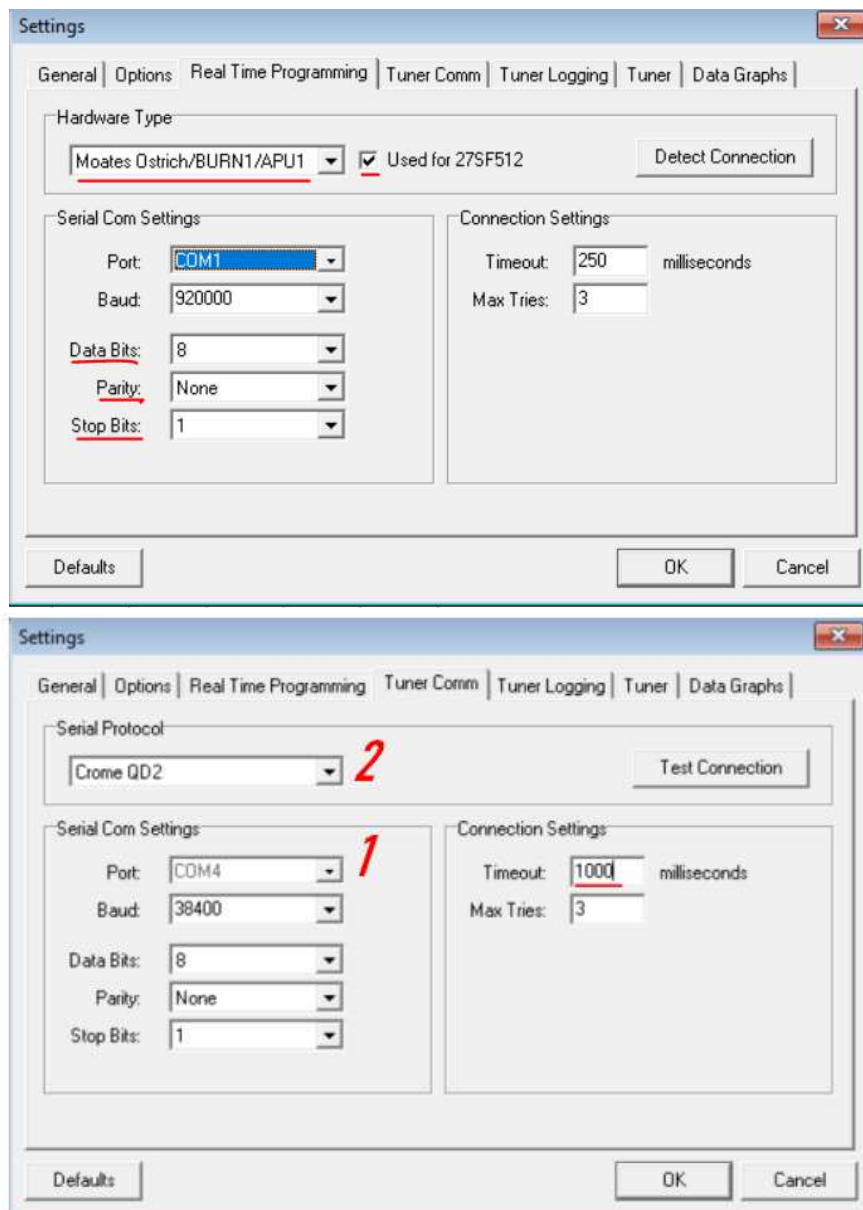

### Notes

- 1) Port for datalog , usually one more than the emulation port number (see Device Manager (COM & LPT)).
- 2) The protocol should be selected QD2, or if you are using Crome Gold - QD3 respectively.

## BRE (OBD0) :

<http://benogle.com/projects/bre.html>

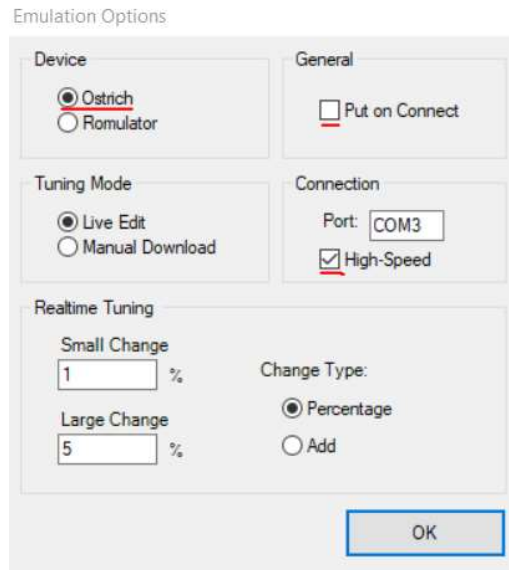

## TurboEDIT (OBD0):

<https://honda-perf.net/turboedit/TurboEDIT%203.2.2%20Full%20Install.exe>

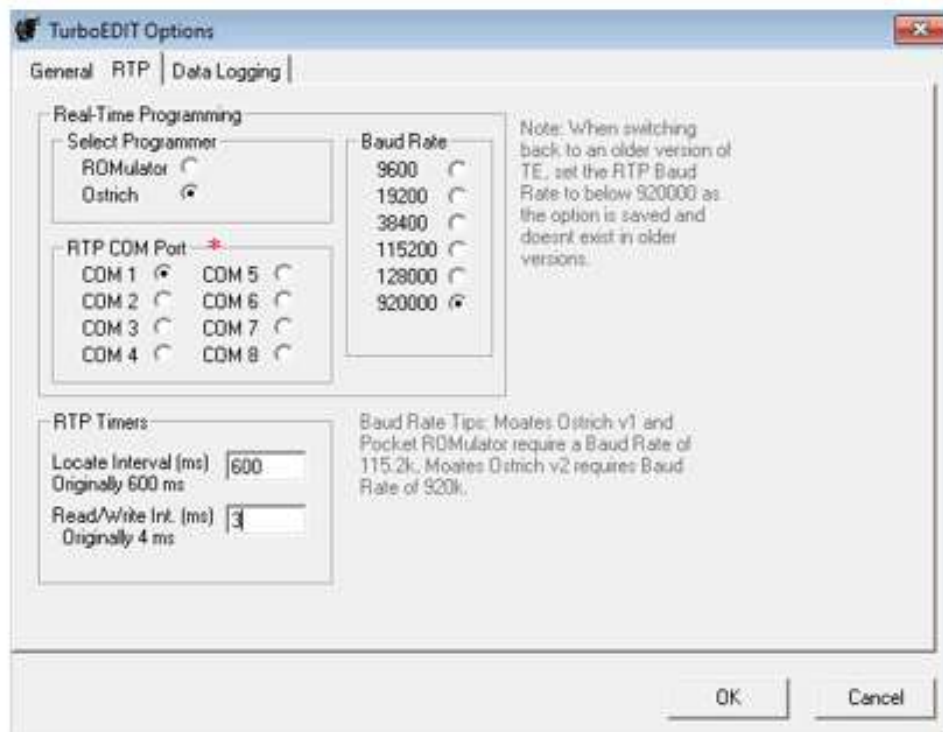



---

## SELECT DATALOG CHANNEL MODE (USB-BT)

This function is available for versions with bluetooth module.  
To select the dataog mode (channel), use the *Service-Configurations* tab in Utility:

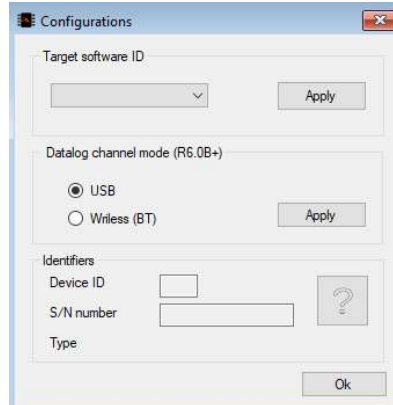

To switch the mode, you must select the appropriate item and save (the selected mode is saved in permanent memory).

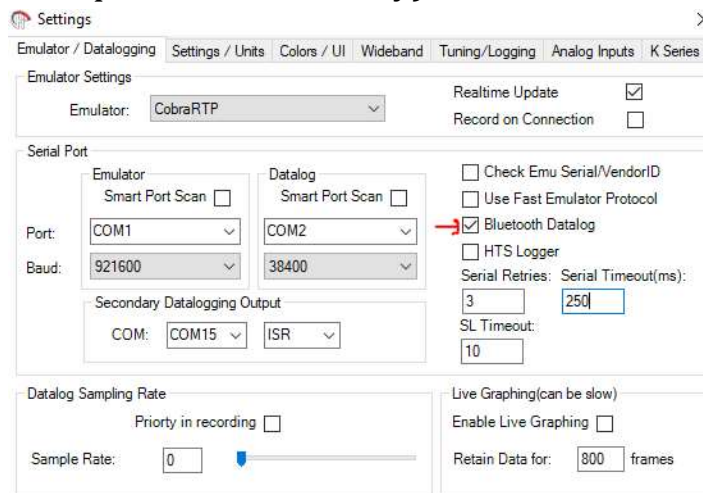

Pssword for BT mode: **1234**

**Tutorial** : <https://youtu.be/y6EdtvHOGY>

### Notes

1. Wireless way of working datalog (BT) is designed primarily to work with the mobile application ( TunerView ), as well as with the Honda Tuning Suite. Performance with other programs is not guaranteed, but possible!
2. To test the Datalog channel in the "Test" tab, use the USB mode.
3. Make sure that the correct COM port for BT datalog is selected, there may be several of them and it does not correspond to the COM port for USB mode!

---

# CONNECTING DEVICES TO AUX IN/OUT INCLUDED IN THE R10 VERSION AND THEIR SETTINGS

## DESCRIPTION OF NEW FEATURES

New functions make it possible to use ethanol content sensors to implement the FlexFuel system with an OBD1 ECU, as well as the ability to connect a knock sensor (hereinafter referred to as **KS**) to monitor engine knock.

The FlexFuel interface on R10 board is a converter of a discrete signal from an ethanol content sensor into an analog 0-5V signal that is “understandable” for the ECU using an analog output as part of the AUX Out. There is also the ability to display readings in tuning software.

The knock sensor interface allows you to connect broadband sensors to monitor the knock sensor signal in tuning software, as well as output the signal to external devices via AUX Out using 0-5V analog output.

## AUX IN/OUT DESCRIPTION

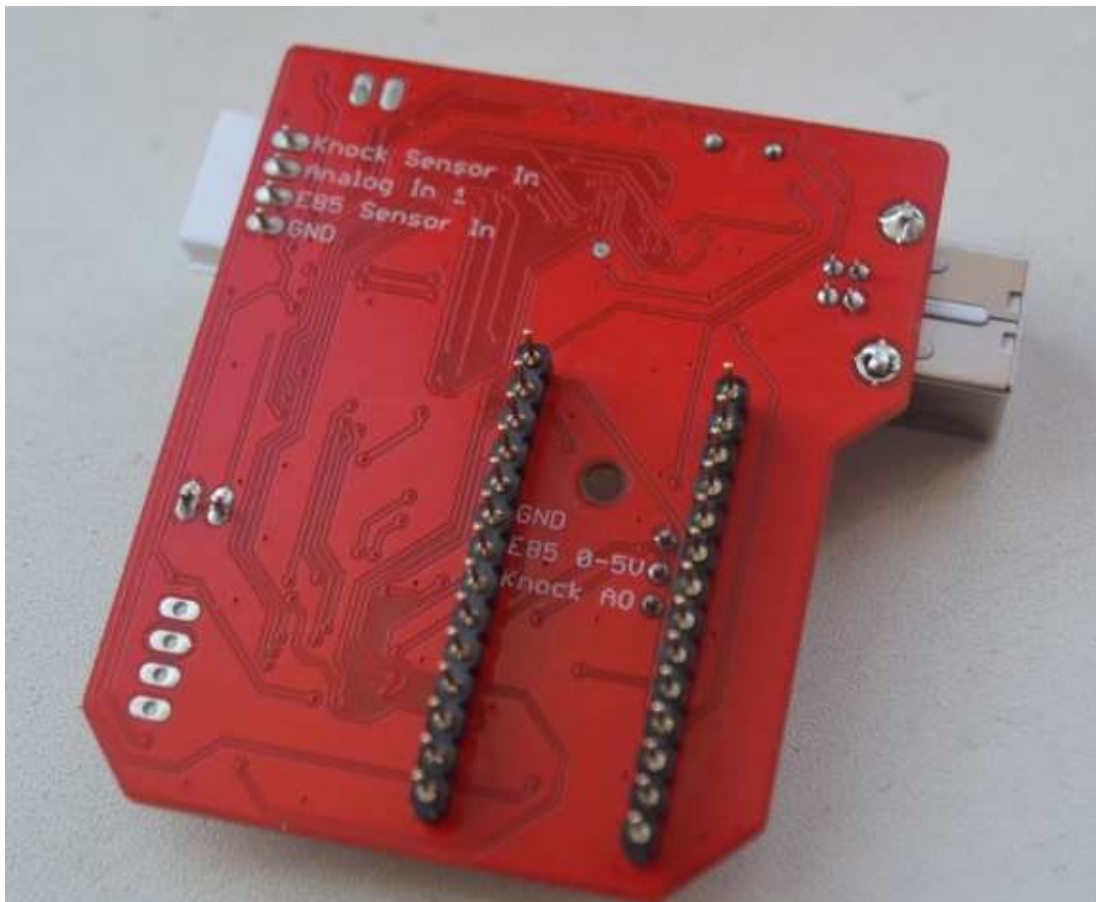

---

**AUX in** – intended for connecting sensors (signal input):

1. *Knock Sensor In* – knock sensor signal input.
2. *Analog In 1* – general purpose analog input (0-5V), works the same as in previous versions. Input resistance 16kOhm.
3. *E 85 Sensor In* – ethanol content sensor input (E85).
4. *GND* – common (ground) relative to all AUX In inputs.

**AUX out** – auxiliary outputs:

1. *Knock AO* (knock audio output) – audio output of the KS signal. Designed for connecting headphones or for recording audio in devices with a microphone input.
2. *E85 0-5V* – configurable analog output with a range of 0-5V. Can be configured as an ethanol content output or as a knock signal level output. Designed for connection to ECU inputs or other indicating devices with 0-5V input.
3. *GND* – common (ground) relative to all AUX Out outputs.

## SELECTION AND CONNECTION OF SENSORS

### Knock sensor.

As a knock sensor, it is necessary to use a broadband piezoelectric sensor with two or three contacts (the third is usually used for shielding), in most cases it looks like this:



### Connection

It is recommended to use a shielded cable for connection to reduce electromagnetic interference:

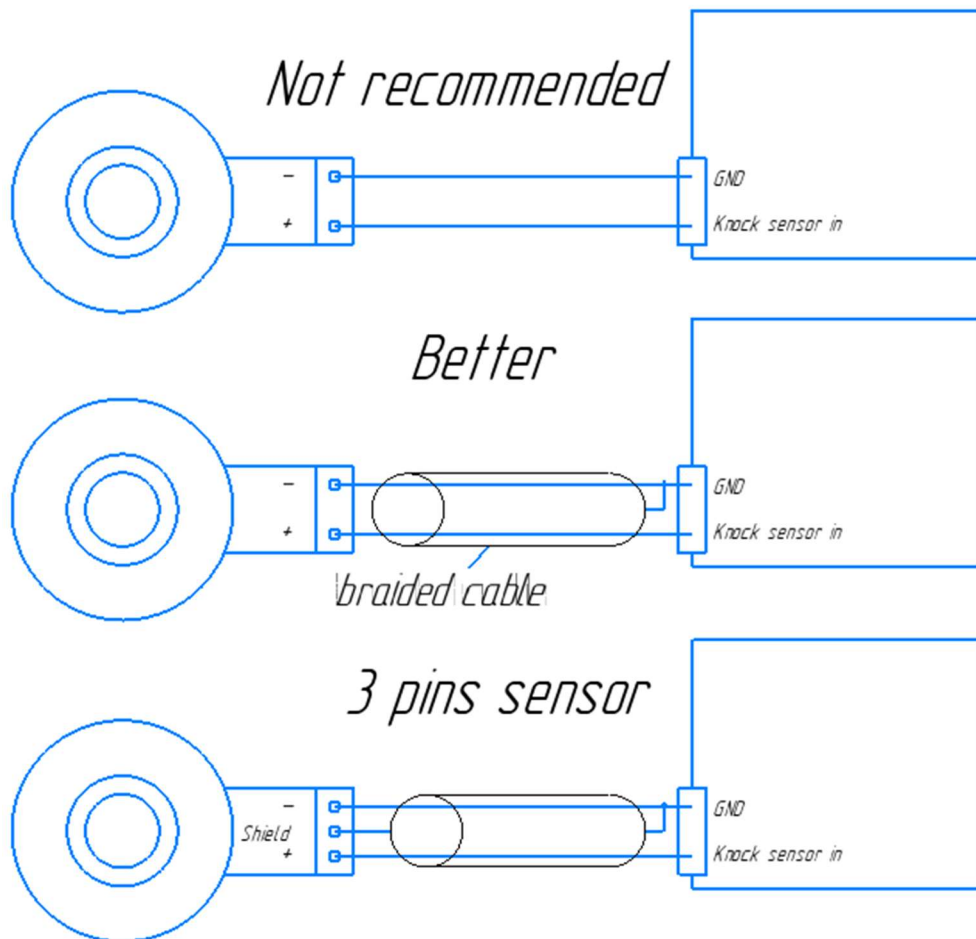

### Installation

The knock sensor should be installed on the cylinder block, ideally in the standard place of the factory KS sensor.

### Ethanol content sensor.

Version R10 is designed to work with an ethanol content sensor with an output signal of 50-150Hz. These include GM sensors: 13507128, 13577429, 13577394.



13577429

## Connection

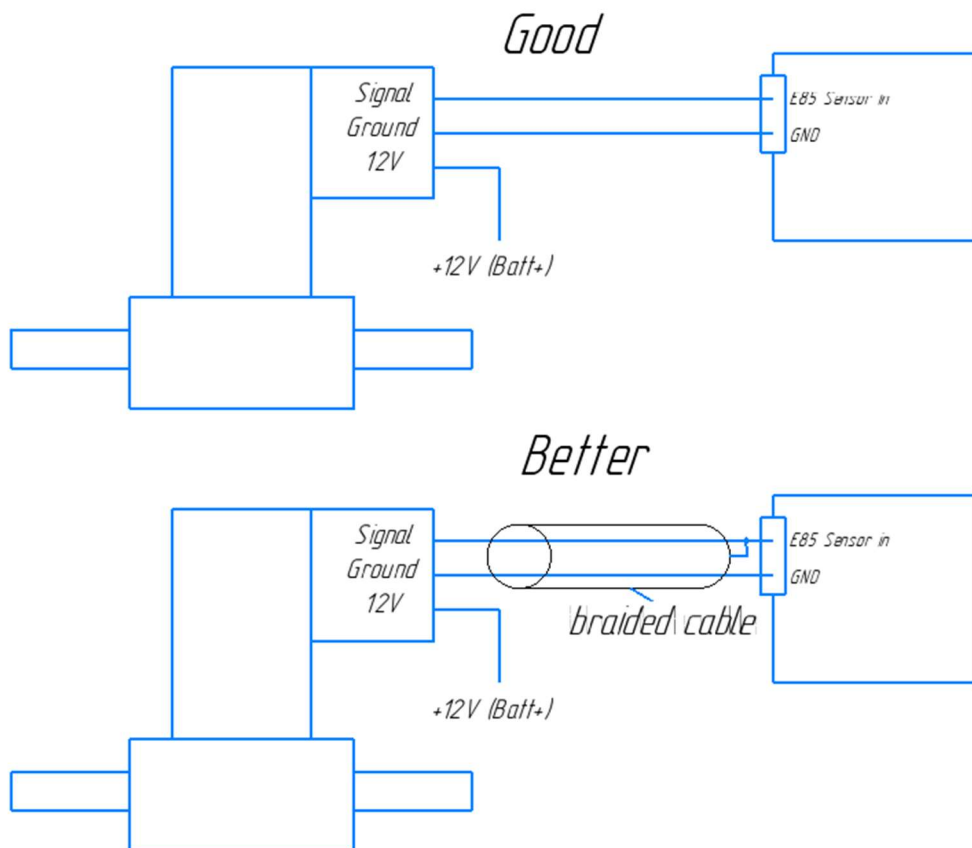

## CONNECTING DEVICES TO AUX OUT

### Headphones.

Use any headphones with a speaker coil impedance of at least 35 ohms and with volume control (optional, but recommended).

## Connection

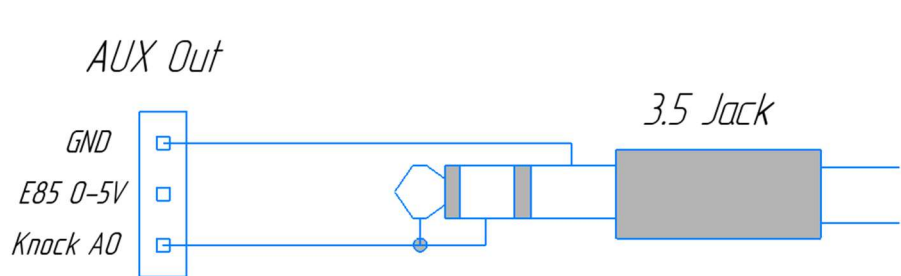

This output can also be connected to a recording device, such as a PC, to record the sound of the knock sensor signal through the microphone input.

## 0-5V Output.

Currently, this output is intended to output parameters such as the processed knock sensor signal or the level of the ethanol content signal in the fuel.

Output mode [1]	Output voltage level	Expected parameter/value
KS linear 0-5V	0 V	Low level
	2.5 V	Mid-level
	5 V [3]	High level
Detonation (0V/5V) [2]	0 V	No detonation detected
	5 V	Detonation detected
E85 0-5V	0 V	0%
	2.5V	50%
	5V [3]	100%

- 1) According to the configurations in CobraRTP Utility, see next.
- 2) If you have a knock detection indicator configured, this mode simply repeats it to the analog output.
- 3) Value may be slightly lower than 5.00V due to imperfections in the output characteristics and supply voltage.

## Connection to ECU

To expand the capabilities of the ECU and enable additional functionality in Honda Tuning Suite, this output must be connected to one of the analog inputs of the OBD1 ECU:

D10 (ELD) (need to remove R136 and R138 on USDM)

D12 (EGR) (recommended)

B6 (need to remove R2 and R3 on USDM).

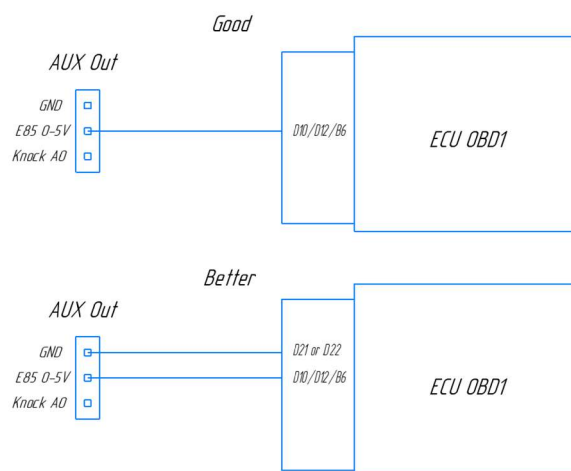

## Notes

1. Be careful when connecting! An incorrect connection may damage the emulator's analog output!
2. AUX Out work correctly only if there is power from the ECU.



---

## AUX IN/OUT CONFIGURATIONS

Configuring AUX ports, as well as other options related to the KS and FlexFuel interface, is done in CobraRTP Utility (Service -> Settings):

***Flex Fuel*** – group of settings for the ethanol content sensor interface. Here you can check the current ethanol content readings and configure the *outputting* of the readings to the datalog channel data stream using the ISR protocol to indicate the ethanol content in HTS , eCtune , etc.

***Knock sensor interface*** – group of settings for the knock sensor interface. Here you can configure the output of readings to the datalog channel data stream using the ISR protocol to indicate the processed KS signal in HTS, eCtune , etc.

***Indicator*** – select an indicator when the detonation detection threshold is reached in the tuning software for the selected channel using the ISR protocol .

***Calibration*** – calibration of the knock sensor (see details below).

***AUX Out configuration*** – 0-5V output settings (E85 0-5V). Here you can set the operating mode of this output.

### Note

Always use the latest version of CobraRTP Utility, and also keep an eye out for device firmware updates!

---

## KNOCK SENSOR CALIBRATION AND KNOCK DETECTION RECOMMENDATIONS

Calibration is necessary to more accurately determine the knock detection threshold in the processed KS signal, and is performed for a specific sensor, engine and sensor installation location. It is also recommended to perform calibration when changing the engine configuration, for example, even after installing a different camshaft, because the overall engine noise may change. **However, the knock sensor interface included in the new version does not provide a 100% guarantee of detonation detection, since this addition is not professional equipment for these purposes, and is designed as an additional feature of this class of device. Although in a particular case this can work very effectively.**

To perform calibration, the sensor must be installed and connected according to the recommendations described above. The emulator must be installed in the ECU and function correctly.

To be ready for calibration, you need to connect to the emulator in CobraRTP Utility and go to *Service -> Configurations -> Calibration*:

Knock sensor calibration

Knock sensor calibration is carried out individually for each sensor, location of the sensor installation on the cylinder block and engine, and is aimed at minimizing influence of natural engine noise on readings.

Calibration conditions:

1. During the test, the knock sensor must be installed on the cylinder block and connected to the CobraRTP board via AUX In.
2. The engine must be running.
3. During calibration you must work through the operating range engine speed (1000-6500 rpm).

**Detect**

Current val    RPM

Coefficients

	500-1000	1000-2000	2000-3000	3000-4000	4000-5000	5000-6000	6000-7000
	<input type="text"/>	<input type="text"/>	<input type="text"/>	<input type="text"/>	<input type="text"/>	<input type="text"/>	<input type="text"/>

The engine must be running before calibration can begin. During the calibration time (about 15 seconds), you must “work through” the entire engine speed range to determine the calibration coefficients for all RPM ranges. Change engine speed smoothly, avoiding sudden accelerations, to more accurately determine the coefficients. After calibration, the calibration parameters are saved in the device memory.

The coefficients in the normal case should be in the range of 10-120, and the maximum value of all should be at high RPM and from about 50 to 120.

**Detect** - Indicates that a knock sensor signal (noise) has been detected.

**Current val** – current noise level around 0-255.

---

To better understand detonation detection, we recommend using **headphones**. In combination with indication in the software, this will allow you to create an accurate picture of the presence of detonation in the KS signal.

The sound of detonation knocking is significantly different from other “rustling” engine noise, which is monotonous and only changes depending on the RPM. The detonation sound is similar to “clicking”, you can easily distinguish it from the natural noise of the engine.

## EXAMPLE OF SETTING UP MONITORING IN TUNING SOFTWARE

Let's look at setting up the display of the knock sensor signal in HTS. For example, let's select signal output via the *BAT Voltage* (battery voltage) channel, and select *SCC* (service check connector) as the detonation detection indicator:

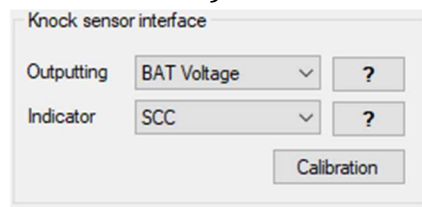

Setting up virtual gauge in HTS:

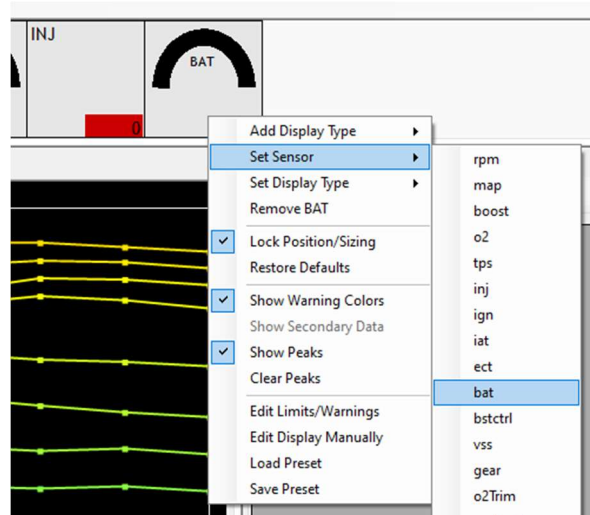

Since this parameter is intended to display the voltage of the on-board network, the ratios will be as follows:

0% - 0 V  
50% - 12 V  
100% - 24 V

For ease of display, the knock sensor signal can be added to Graph to present the signal as a live graph:

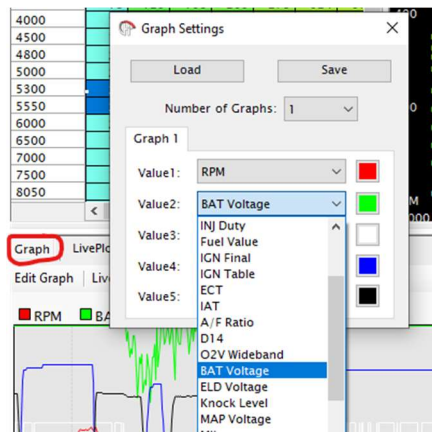

We will also configure the indication of the detonation detection signal:

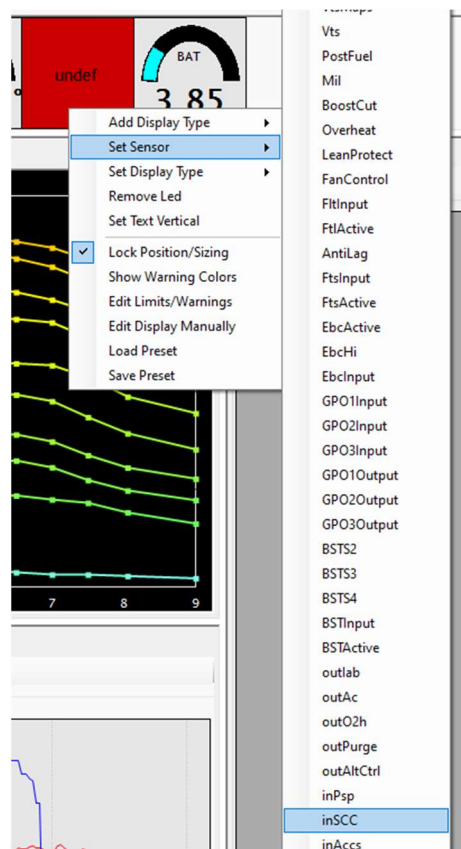
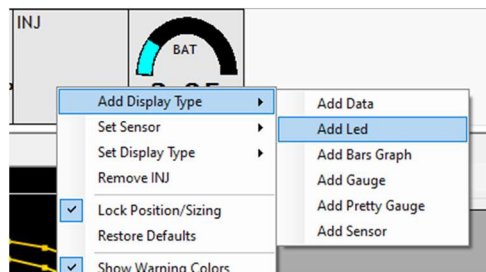

---

On Graph you can also add a signal from this indicator and analyze both signals on one chart:

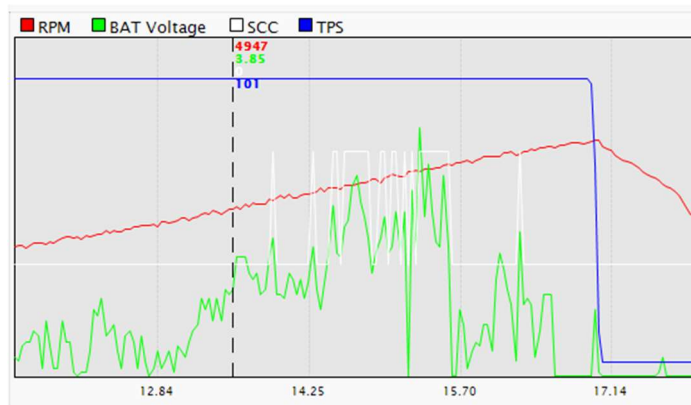

Don't forget to turn on Live Graphing for real-time monitoring when datalog is enabled :

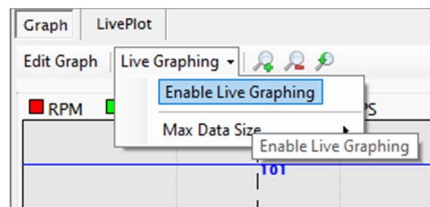

Similarly, you can customize the display for FlexFuel .

---

## CONFIGURING AUX INPUT IN VERSIONS R8-R9

The analog inputs in the versions up to R9 are used as an option (AUX) to expand the capabilities of the limited analog inputs in the ECU.

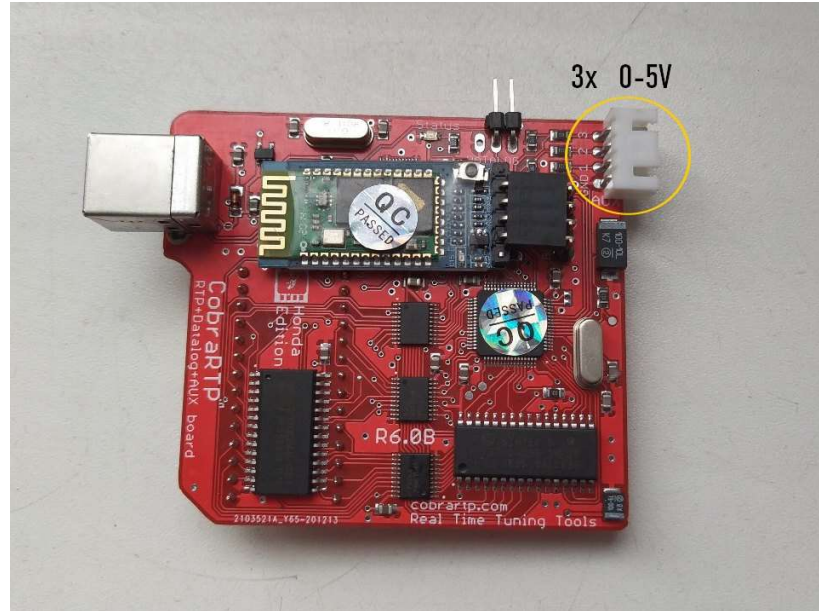

### Settings for HTS:

Settings

Emulator / Datalogging Settings / Units Colors / UI Wideband Tuning/Logging Analog Inputs

ECU Demon CobraRTP

Enable CobraRTP Inputs  
70 Polling timeout

Note: CobraRTP onboard analog will be read every 70ms.

Analog Input 1	
Voltage	Value
0.00	0.00
5.00	6.34

Units: V  
Decimals: 2

Analog Input 2	
Voltage	Value
0.00	0.00
5.00	6.34

Units: V  
Decimals: 2

Analog Input 3	
Voltage	Value
0.00	0.00
5.00	6.34

Units: V  
Decimals: 2

This function is included with datalog:



Data	Value
GPO 1 Input	<input type="checkbox"/>
GPO 1 Output	<input type="checkbox"/>
GPO 2 Input	<input type="checkbox"/>
GPO 2 Output	<input type="checkbox"/>
GPO 3 Input	<input type="checkbox"/>
GPO 3 Output	<input type="checkbox"/>
-----	
Cobra AUX	
-----	
EmuAux1	
EmuAux2	
EmuAux3	
EmuAux4	
EmuAux5	

Also analog inputs (AUX) can be checked and configured in the CobraRTP utility *Service - Analog in* :

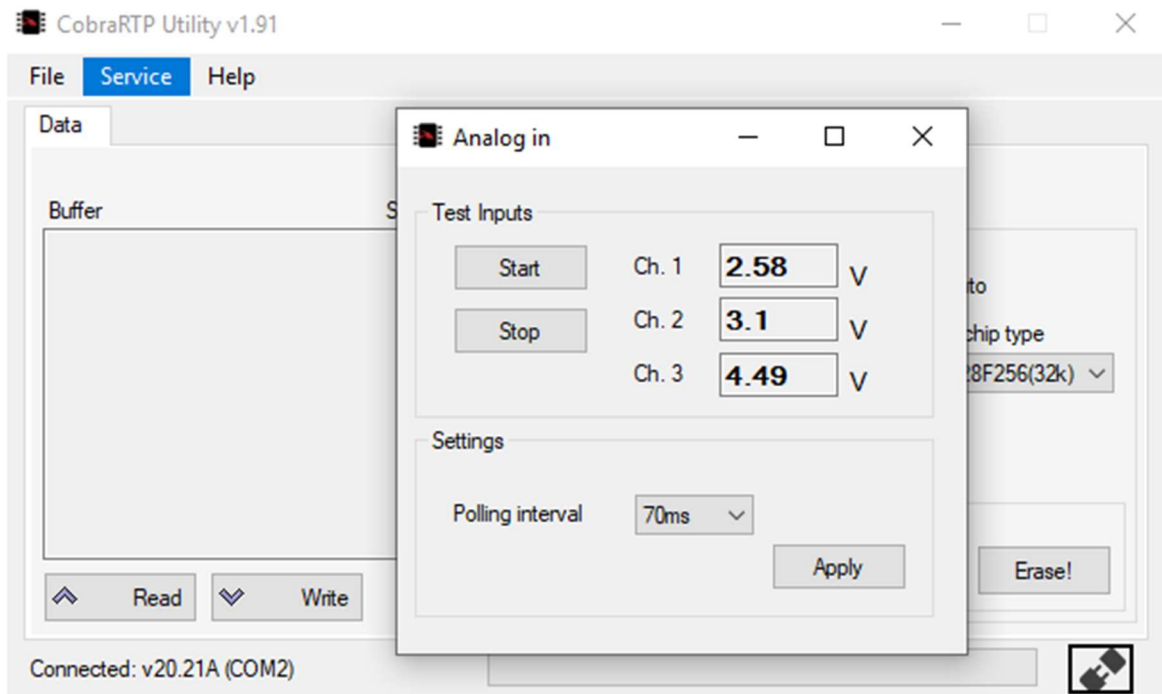

The voltage will correspond to that specified for one or more channels (1-2-3) between GND.

---

# INSTALLING BLUETOOTH (BT) MODULE

To do this, you need any BT module with the ability to provide the following settings:

- speed must be set to: 38400 bps/s (baud)
- power supply voltage ( Vcc -GND): 5V

The connection diagram is shown below:

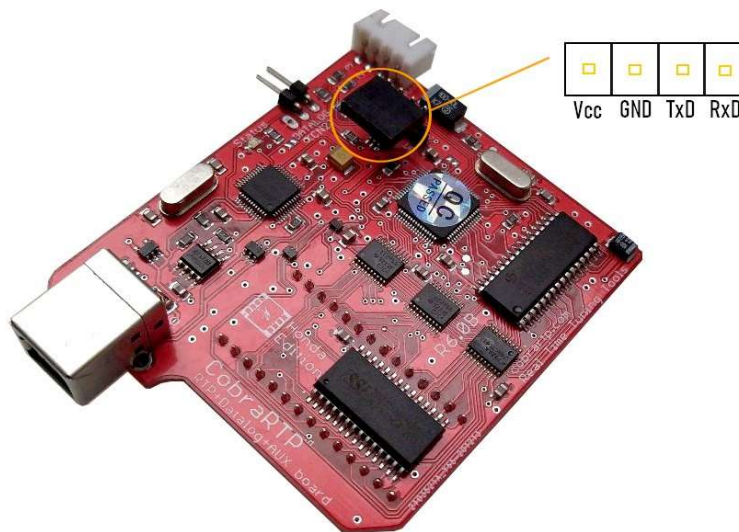

**Note :** the direction of the TX / RX lines is shown inverse, ie the way the pins of the bluetooth module should be located. For example HC-05 is fully compatible.

---

## DUAL-MAP FEATURE

CobraRTP Honda Edition starting with revision R7 allows the upload and use of two different basemap's (Bin). For this, a “Dual- mod ” jumper is provided on the board, with the help of which the firmware is selected (memory block):

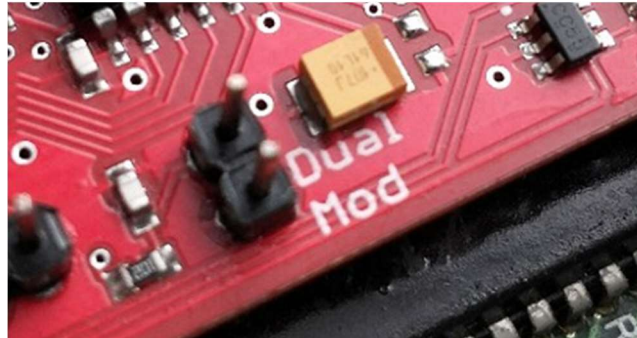

### Upload two ROMs (basemap)

Firmware download is performed in the following order:

1. Upload ROM1 (jumper installed - contact closed)
2. Upload ROM2 (jumper removed - contact open)

Thus, by closing and opening the contact of the “Dual-Mod” jumper, we select a memory block and upload different firmware into different areas of the emulator's memory.

### Using

For use, you can select the desired memory area, ie ROMx using the jumper state (closed / open), in accordance with the order of the uploaded.

For the convenience of switching, you can use a toggle switch brought out at a short distance (no more than 1m is recommended) using a cable.

It is allowed to switch firmwares with the engine running.

Also, you can see the video instruction: <https://youtu.be/CiyAftnVTD0>

---

# STATUS INDICATOR

On the CobraRTP board of all variants, LED indicators of the current state of the device are provided:



**Status** – emulator status indicator has 2 modes:

1. Battery \_ life :

At the first power supply, the indicator lights up and is constantly lit during operation.

2. Tuning :

When the emulator is connected to the software, the indicator will off, and it will only light up again during identification, read, write, and verification operations.

---

# TROUBLESHOOTING

## 1. Connection issues in tuning software

### Decision:

- check if the **software ID** is selected correctly in **CobraRTP Utility**
- check if the COM port number is selected correctly
- check if the device is connected in other software at the moment (**COM port can be connected in only one software**)

## 2. Datalog issues

### Decision:

- Check if the datalog wires are connected correctly
- Check if the COM port for the datalog is correctly selected ( **differs from the emulation COM port number** )
- Check baud for datalog COM in software settings
- Check serial timeout
- If you have a version with **bluetooth** - make sure that the used datalog channel is selected in the configurations ( CobraRTP Utility) ( **see above** )

If the issue with datalog persists, check the compatibility of your computer with the datalog . Jumper j12 (j4 for JDM) is removed, J1 is installed, is the base ROM loaded, etc.), and check CobraRTP hardware in the **CobraRTP Utility** in the **Service** ->“ **Test (hardware)** ” option.

Also, one of the rare causes that have been discovered by our customers is a pin-to-pin short circuit for FTDI USB controller (only for R2-R7.4 boards):

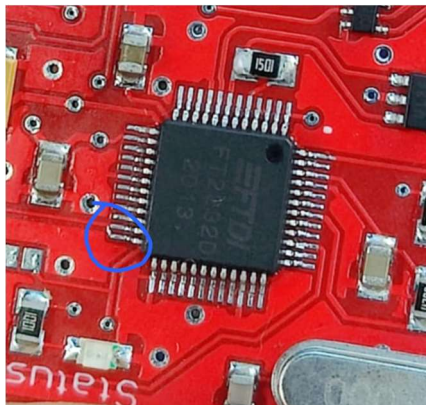

- 
3. Base Rom is loaded but car won't start and is in emergency mode (Check Engine light (MIL) is on all the time)

**Decision:**

- Check if unused sensors are disabled in options (HTS, eCtune , BmTune )
- Make sure that Baserom is compatible with your ECU
- Check 28 pin socket contacts
- Make sure that if J1 is installed and have good contact in the ECU
- Check CobraRTP hardware in CobraRTP Utility ( *Service - Test - ROM* )

If the test result is negative, then check the board, it may be a pin-to-pin short circuit. In this case, you should check all the pins:

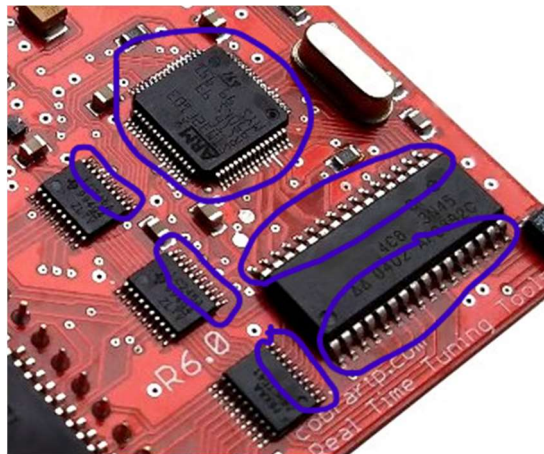

To test the main nodes of the board hardware, you can use the built-in functions in CobraRTP Utility ( *Service ->Test*):

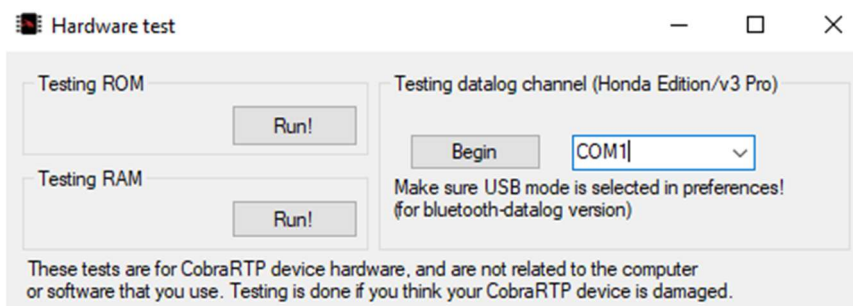



---

# SPECIFICATIONS

1. Supply voltage .....5 V ( $\pm 10\%$ )
2. Supply current (active) ..... 100 mA
3. Memory access time .....60 ns
4. Memory access time when memory changes, no more ... ..250 ns
5. Analog input 1 resistance.....16 kOhm
6. Ambient temperature ..... -20...70°C